

AUFBAUANLEITUNG SONDERFUSSGESTELL MOD. 5037

Assembly instructions special supporting frame model no. 5037

Instructions de montage piètement spécial Réf. 5037

CLASSIC DUO (MOD. 114)

CONODUO

ELLIPSO DUO/ELLIPSO DUO OVAL

INCAVA

PLAZA DUO

PURO/PURO DUO

SILENIO

STUDIO/STUDIO STAR

VAIO 6/VAIO 6 STAR

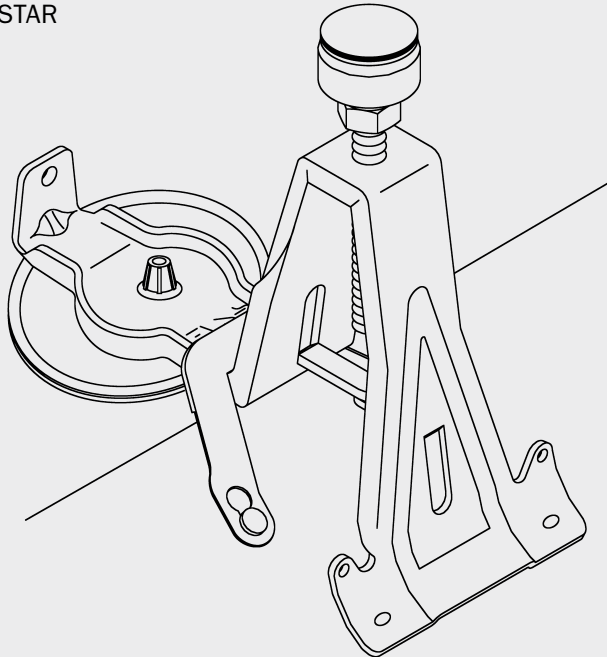

1. Wanne mit Verpackung auf den Boden legen.

Place the bath with its packaging upside down.

Poser la baignoire dans son emballage par terre.

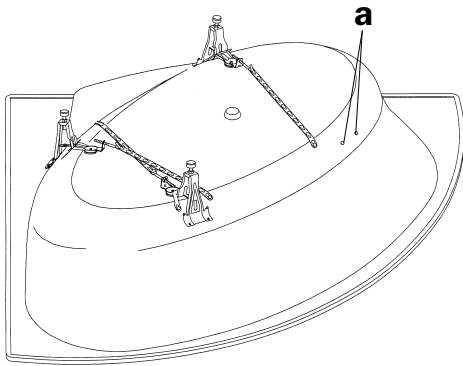

2. Die Haltelaschen des Wannenfußes (b) auf die Haltebolzen (a) der Wanne schieben.

Slot the arm straps of the bath cradle (b) onto the lugs (a) on the base of the bath.

Glisser les supports des pieds de la baignoire (b) dans les chevilles (a).

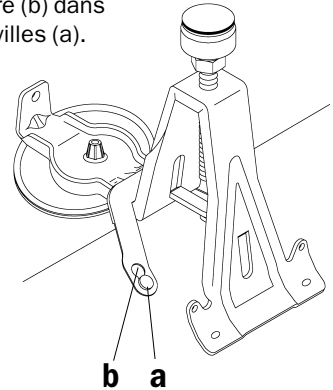

3. Das Spannband mit passender Länge auf den Haltebolzen (a) schieben, den Gewindehaken (c) einhängen und mit der Mutter am Fuß handfest anziehen.

Push a suitable length of the tensioning belt onto the retaining bolt (a), engage the threaded hook (c) and tighten by hand using the nut on the base.

Glisser la bande de serrage de longueur adéquate sur le boulon de retenue (a), insérer le crochet à tige filetée (c) et le serrer à la main sur le pied avec l'écrou.

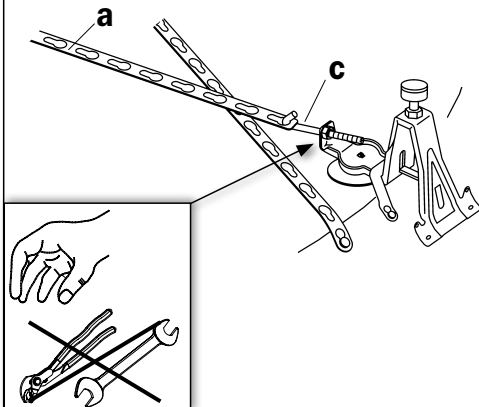

4. Wanne umdrehen, ausrichten und Kontermutter (d) anziehen.

Unter Verwendung des Kaldewei Schalldämmsets und bei sachgemäßem Einbau werden die Anforderungen der DIN 4109/A1 erfüllt. Wannen sind zusätzlich mit Wannenanker (nicht im Lieferumfang enthalten) zu montieren.

Turn over bath, align with the help of a spirit level by turning the screw and tighten the locknut (d). With the use of the Kaldewei sound insulation set, and provided installation is effected properly, the requirements of DIN 4109/A1 are fulfilled.

Baths must also be mounted with bath anchors (not included in the scope of delivery).

Retourner la baignoire, la mettre de niveau avec un niveau à bulle en tournant les vis et serrer le contre-écrou (d). Une installation effectuée correctement à l'aide du kit d'insonorisation Kaldewei respecte les exigences de la norme DIN 4109/A1.

Il faut également monter les baignoires avec l'élément d'ancrage pour baignoire (non fourni).

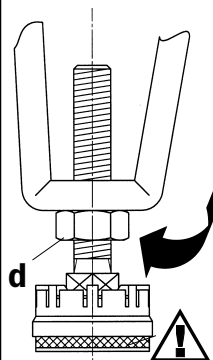

ELLIPSO DUO/
ELLIPSO DUO OVAL

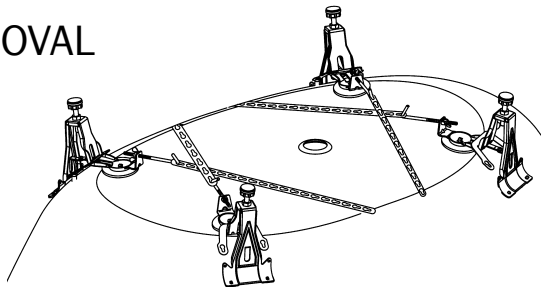

PLAZA DUO

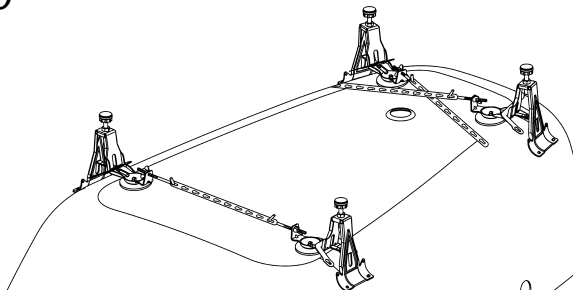

PURO

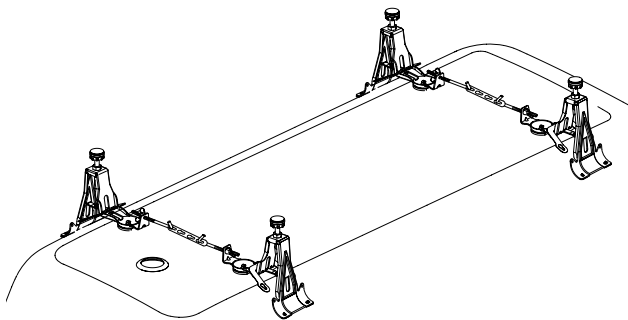
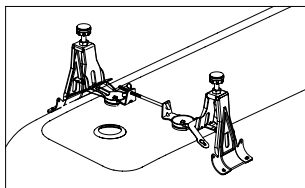

CLASSIC DUO (MOD. 114)
CONODUO
PURO DUO

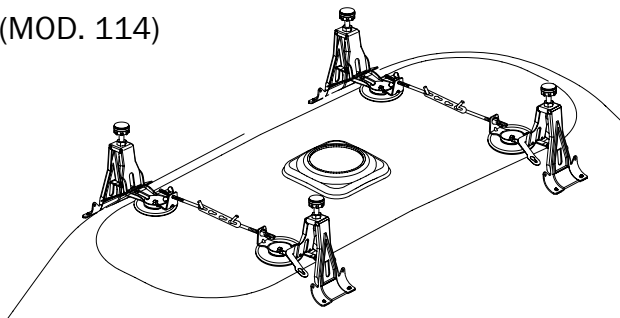

INCAVA SILENIO

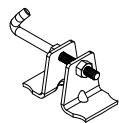

170x75
Mod. 172, Mod. 674

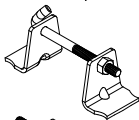

180x80
Mod. 174, Mod. 676

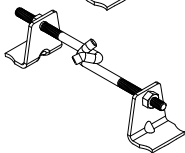

190x90
Mod. 176, Mod. 678

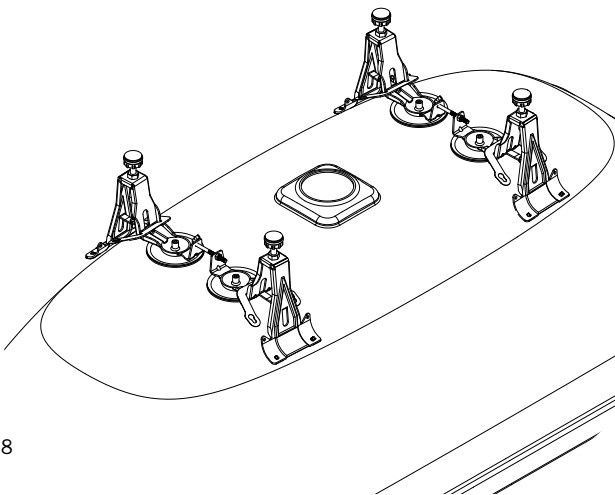

STUDIO / STUDIO STAR

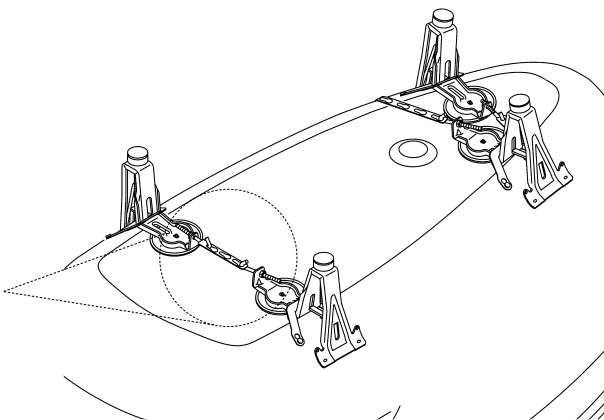
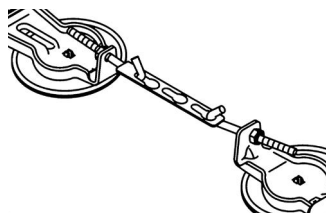

VAIO 6 / VAIO 6 STAR

